

## Ultra-compact SMD Type with a detectable sensing distance of 1 mm

- PCB surface mounting type.
- Support for small lots. \*1
- Sorting specifications available. \*2

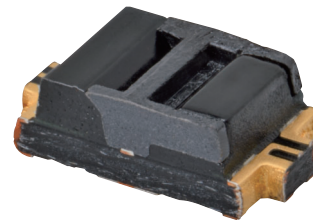

**⚠** Be sure to read *Safety Precautions* on page 3.

RoHS Compliant

## Model Number Structure

**EE-S Y 1 99**

(1)	(2)	(3)	(4)
(1)	(2)	(3)	(4)
Photomicrosensor	Reflective	Phototransistor output	Serial number

## Ordering Information

### Photomicrosensor

Appearance	Sensing method	Connecting method	Sensing distance	Output type	Model	Minimum packing unit (Unit: pcs)
	Reflective	SMT	1 mm	Phototransistor	EE-SY199 *1 *2	2,000 *1

\*1. Types with 100 pcs/box re available. The model name for ordering is EE-SY199-1.

\*2. Photocurrent types available. The model name for ordering is EE-SY199-RANKB.

Note: Order in multiples of minimum packing unit.

## Ratings, Characteristics and Exterior Specifications

### Absolute Maximum Ratings (Ta = 25°C)

Item	Symbol	Rated value	Unit
<b>Emitter</b>			
Forward current	IF	50 *1	mA
Reverse voltage	VR	6	V
<b>Detector</b>			
Collector-Emitter voltage	VCEO	35	V
Emitter-Collector voltage	VECO	6	V
Collector current	IC	20	mA
Collector dissipation	PC	75 *1	mW
Total allowable loss	Ptot	100 *1	mW
Operating temperature	Topr	-25 to 85	°C
Storage temperature	Tstg	-40 to 100	°C
Reflow soldering temperature	Tsol	260 *2	°C

\*1. Refer to the temperature rating chart if the ambient temperature exceeds 25°C.

\*2. Complete soldering within 5 seconds.  
For reflow soldering, use the conditions given on page 5.

### Exterior Specifications

Connecting method	Weight (g)	Material
		Case
SMT	0.008	Polyphenylene sulfide (PPS)

### Electrical and Optical Characteristics (Ta = 25°C)

Item	Sym bol	Value			Unit	Condition	
		MIN.	TYP.	MAX.			
<b>Emitter</b>							
Forward current	VF	---	1.2	1.4	V	IF = 20 mA	
Reverse voltage	IR	---	---	10	μA	VR = 6 V	
Peak emission wavelength	λP	---	950	---	nm	---	
<b>Detector</b>							
Light current	EE-SY199	IL	40	85	130	μA	IF = 4 mA, VCE = 2 V, Aluminum-deposited surface, d = 1 mm *
	EE-SY199-RANKB		65	---			
Dark current	ID	---	1	100	nA	VCE = 20 V, 0 lx	
Leakage current	I <sub>LEAK</sub>	---	---	500	nA	IF = 4 mA, VCE = 2 V, with no reflection	
Collector-Emitter saturated voltage	VCE(sat)	---	---	---	V	---	
Peak spectral sensitivity wavelength	λP	---	930	---	nm	---	
Rising time	tr	---	20	100	μA	VCC = 2 V, RL = 1 kΩ, IL = 100 μA, d = 1 mm *	
Falling time	tf	---	20	100	μA	VCC = 2 V, RL = 1 kΩ, IL = 100 μA, d = 1 mm *	

\* Refer to Fig 12. Light Current Measurement Setup Diagram on page 2.

Engineering Data (Reference value)

Fig 1. Forward Current vs. Collector Dissipation Temperature Rating

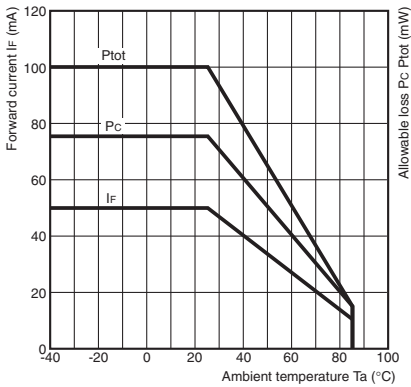

Fig 2. Forward Current vs. Forward Voltage Characteristics (Typical)

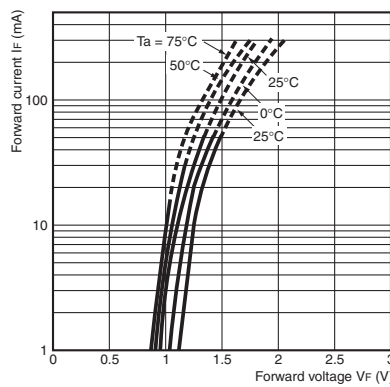

Fig 3. Light Current vs. Forward Current Characteristics (Typical)

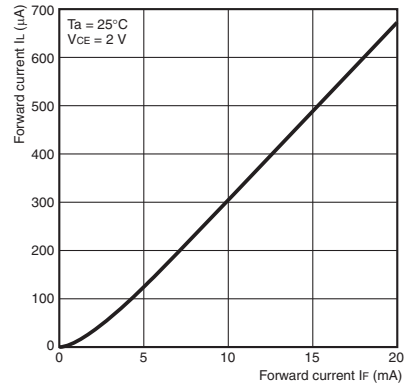

Fig 4. Light Current vs. Collector-Emitter Voltage Characteristics (Typical)

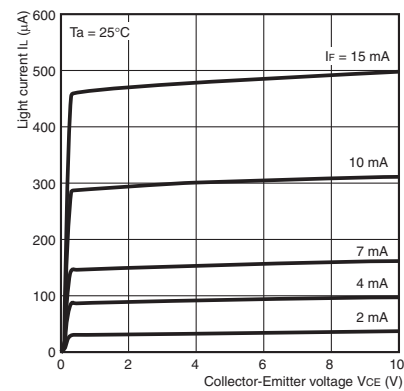

Fig 5. Relative Light Current vs. Ambient Temperature Characteristics (Typical)

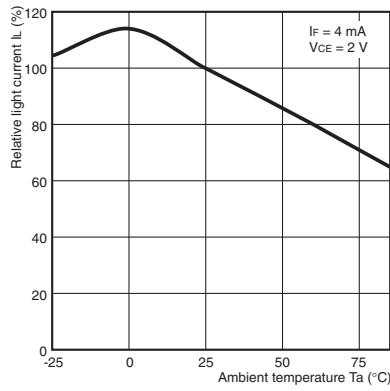

Fig 6. Dark Current vs. Ambient Temperature Characteristics (Typical)

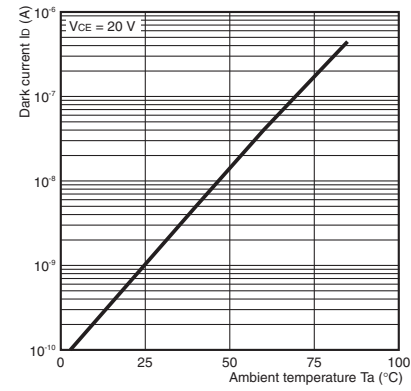

Fig 7. Response Time vs. Load Resistance Characteristics (Typical)

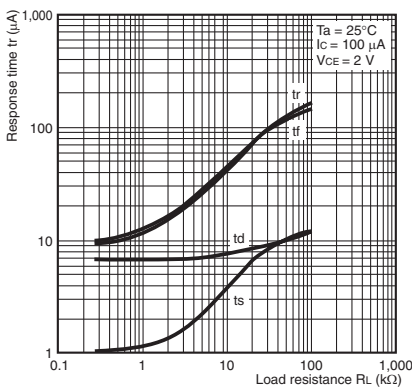

Fig 8. Relative Light Current vs. Distance Characteristics (Typical)

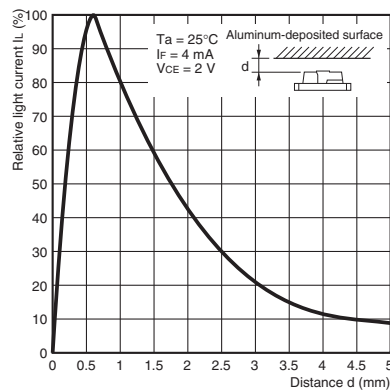

Fig 9. Relative Light Current vs. Card Moving Distance Characteristics (Typical)

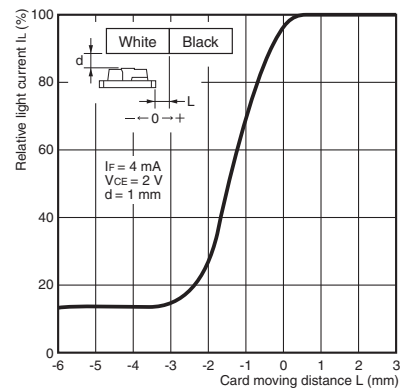

Fig 10. Relative Light Current vs. Card Moving Distance Characteristics (Typical)

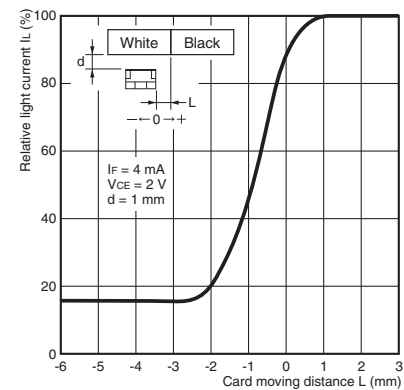

Fig 11. Response Time Measurement Circuit

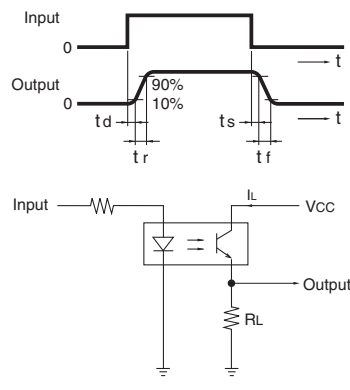
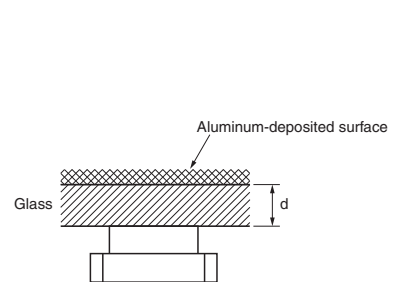

Fig 12. Light Current Measurement Setup Diagram



## Safety Precautions

To ensure safe operation, be sure to read and follow the Instruction Manual provided with the Sensor.

### CAUTION

This product is not designed or rated for ensuring safety of persons either directly or indirectly. Do not use it for such purposes.



### Precautions for Safe Use

**Do not use the product with a voltage or current that exceeds the rated range.**

Applying a voltage or current that is higher than the rated range may result in explosion or fire.

**Do not miswire such as the polarity of the power supply voltage.**

Otherwise the product may be damaged or it may burn.

**This product does not resist water. Do not use the product in places where water or oil may be sprayed onto the product.**

### Precautions for Correct Use

**Do not use the product in atmospheres or environments that exceed product ratings. This product is for surface mounting. Refer to Soldering Information, Storage and Baking for details.**

**Dispose of this product as industrial waste.**

## Dimensions and Internal Circuit

(Unit: mm)

### Photomicrosensor

EE-SY199

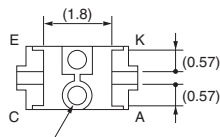
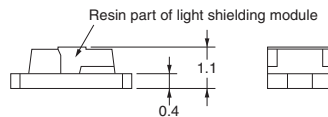
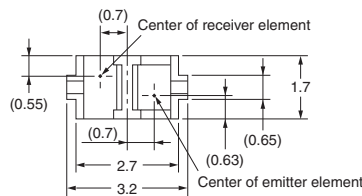

Direction pattern (NC)

Terminal No.	Name
A	Anode
K	Cathode
C	Collector
E	Emitter

### Recommended Soldering Pattern

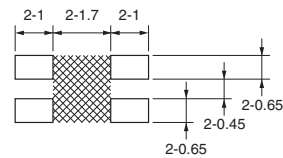

- Note:**
- The shaded portion in the above figure may cause shorting. Do not wire in this portion.
  - The dimensional tolerance for the recommended soldering pattern is  $\pm 0.1$  mm.

### Internal circuit

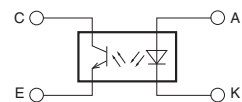

Unless otherwise specified, the dimensional tolerance is  $\pm 0.15$  mm.

## Tape and Reel

### Reel (Unit: mm) \*

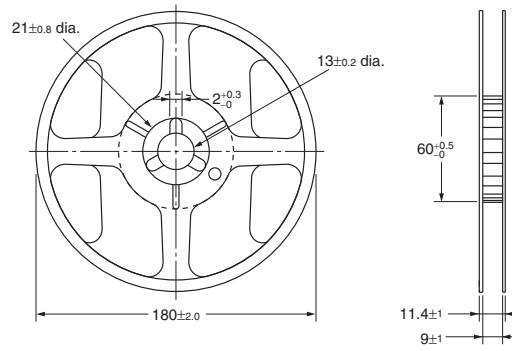

### Tape (Unit: mm)

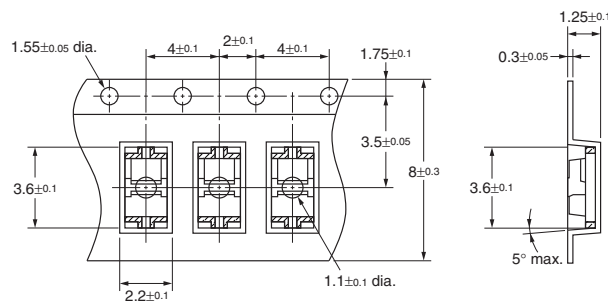

### Part Mounting

The devices are oriented in the rectangular holes in the carrier tape so that the edge with the LED faces the round feeding holes.

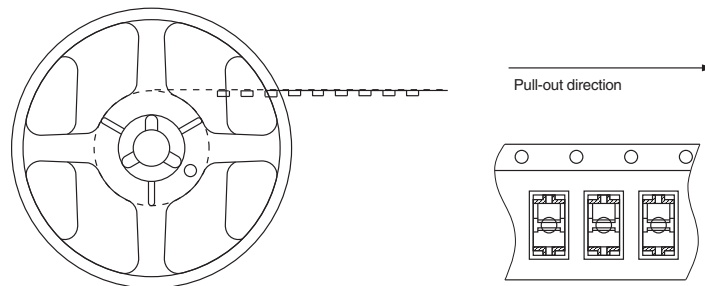

### Tape quantity

2,000 pcs./reel  
100 pcs./pack \*

\* EE-SY199-1 (100 pcs./pack) has no reel, only tape is attached.

### Packing Specifications

- One reel is sealed in an aluminum-laminated bag.
- The model number, lot number, and quantity are given on the label.

## Soldering Information

### Reflow soldering: Temperature profile

The reflow soldering must be completed in one time and must comply with the following diagram.

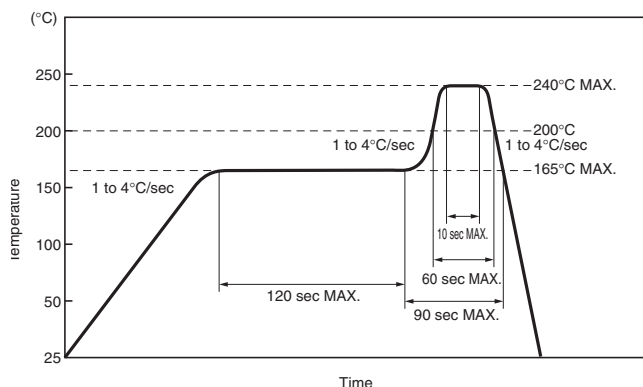

### Solder Quantity

The pin's wiring pattern between the package and the board must not be soldered. Doing so would result in damage to the product's reliability. Make sure to adjust the solder quantity to the product sidewall of the terminal.

### Other Notes

- The use of an infrared lamp causes the temperature of the resin to rise partially too high.
- Do not immerse the resin part into the solder.
- Test the soldering method under actual conditions and make sure the soldering works fine, since the impact on the junction between the device and PCB varies depending on the cooling and soldering conditions.

## Storage

### Storage conditions

Store the product under the following conditions:

Temperature: 5 to 30 °C

Humidity: 70% max.

### Treatment after open

1. After opening the bag, store the products between 5 and 25°C at 60% humidity or lower and mount them within two days.
2. If storage for longer than two days after opening the bag is required, use a dry box or reseal the products in a moisture-proof bag with a commercially available desiccant. Store them between 5 and 30°C at 70% humidity or lower, and mount them within two weeks.

## Baking

If the above treatment could not be carried out, mounting is still possible after baking treatment.

However, baking treatment must be limited to only one time.

Recommended conditions: 125°C, 16 to 24 hours

**Note:** Do not bake the products while they are still in the bag. Temporarily mount them to the PCB or place them in metal trays.

### Cleaning Conditions

Cleaning in Solvent:

Solvent temperature: 45°C max.

Immersion time: 3 hours max.

Ultrasonic Cleaning:

Do not use ultrasonic cleaning.

Recommended Solvents:

Ethyl alcohol, methyl alcohol, or isopropyl alcohol

Please check each region's Terms & Conditions by region website.

---

## **OMRON Corporation**

**Electronic and Mechanical Components Company**

### **Regional Contact**

#### **Americas**

<https://www.components.omron.com/>

#### **Asia-Pacific**

<https://ecb.omron.com.sg/>

#### **Korea**

<https://www.omron-ecb.co.kr/>

#### **Europe**

<http://components.omron.eu/>

#### **China**

<https://www.ecb.omron.com.cn/>

#### **Japan**

<https://www.omron.co.jp/ecb/>